



DAHE PUMP



豐禾電機有限公司
FENG HE ELECTRIC CO., LTD



DAHE PUMP

豐禾電機有限公司
FENG HE ELECTRIC CO., LTD.

ADD:No. 38-1, Ln. 298, Guanghua Rd., Daliao Dist.,
Kaohsiung City 831 , Taiwan (R.O.C.)

TEL:+886-7-7875375

FAX:+886-7-7870315

Email:fenghe.pump@msa.hinet.net

Professional Pump
Manufacturer

Innovative Technology
Integrity Service

Providing Products
and Services



CE Certification



ISO9001:2015



International
Accreditation Forum



Arise International
Certification

Business Scope

- 01 ➤ Submersible Pumps
- 02 ➤ Amphibious Pumps
- 03 ➤ Pumps for Sewage
- 04 ➤ Large Drainage Axial Flow Pumps
- 05 ➤ Pumps for Wastewater
- 06 ➤ High Head, Large Flow Diagonal Flow Pumps
- 07 ➤ All-Stainless Steel Pumps
- 08 ➤ Vertical Multi-Stage Pumps (Dual Impellers)
- 09 ➤ Other Pump Products

After enduring long-term market testing, we have refined our products to achieve high reliability and durability. With advanced production equipment and strict quality control, we provide high-quality products and services. Our products are certified with ISO 9001 International Quality Certification, European Safety Standard CE, IAF (International Accreditation Forum), and ARES (Arise International Certification), ensuring competitiveness in the market and meeting our customers' quality demands.



CE Certification



ISO9001:2015



International
Accreditation Forum



Arise International
Certification



Product Features



**PROFESSIONALISM
QUALITY**

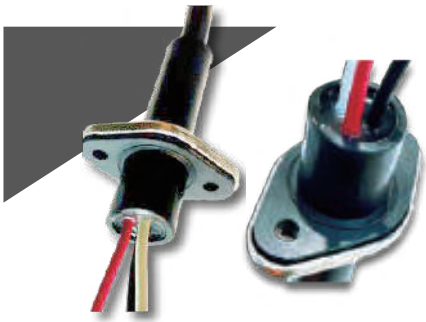

- The motor cable ends are integrally molded for complete waterproofing.
- The cable bundle tube is filled with sealing gel and specially reinforced with waterproofing treatment, effectively preventing moisture from entering the motor housing through the cables.



- The pump motor body, shaft, and screws are all made of stainless steel material.



- The pump's main shaft is made of stainless steel and undergoes dynamic balance calibration, which extends the lifespan of the bearings.

Through continuous research, design improvements, and staying up-to-date with evolving technology, we implement comprehensive quality management to enhance product quality. By paying close attention to every detail of quality control, we provide a full-range pump solution philosophy. Our goal is to meet customer service needs by offering the highest quality products and services, creating the greatest economic value for our clients.



**TECHNOLOGY
SERVICE**

Product Introduction

AS Series Non-Clog Sewage Submersible Pump

Applications

Various wastewater treatments, drainage for farms and pigsties, drainage for purification tanks and chemically treated water, and drainage for various industries in the discharge of wastewater, rainwater, and groundwater.



➤ AS-04



➤ AS-1.52



➤ AS-104

Features

1. This series of pumps use brand new motor silicon steel sheets; the shaft and rotor are processed at high speed with precision, ensuring stable motor operation.
2. The internal design of this series of pumps features a mechanical shaft seal and a stainless steel shaft with a wear resistant liner for durability.
3. The impeller is sturdy and wear resistant, made of special materials, allowing for easy pumping of various sewage and waste water. ※It can also be equipped with a special impeller (U shaped) design, balanced and calibrated, making it more suitable for handling soft or fixed debris without clogging.
4. The motor body and main shaft of this series of pumps are made of stainless steel; the shaft seal uses SIC mechanical wear resistant shaft seals.

※Float switch can be optionally installed for pumps of 2HP and below.

※Optional attachment and detachment device can be combined for easy lift ing and lowering of the pump to match pipe diameters, making it easy to detach from the pipe diameter in the hole, facilitating inspection and maintenance operations.



■ U-type Non-clog Impeller



■ TOS-AS Type Attachment and Detachment Device Diagram

Performance Curve

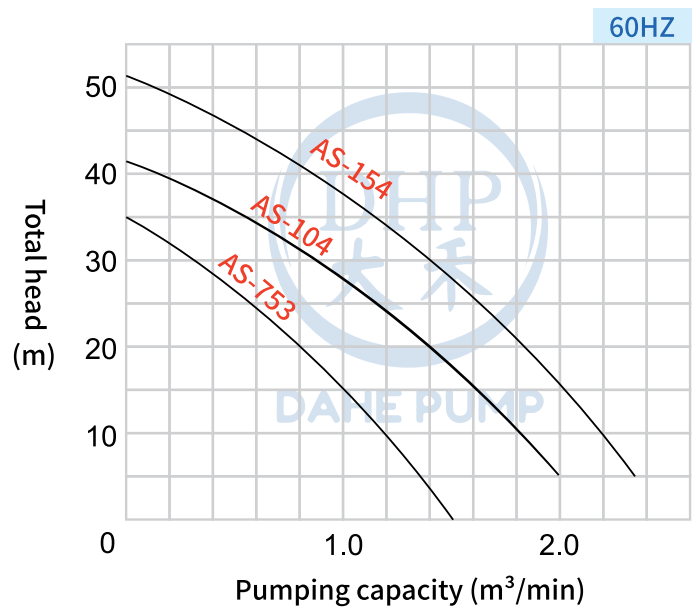
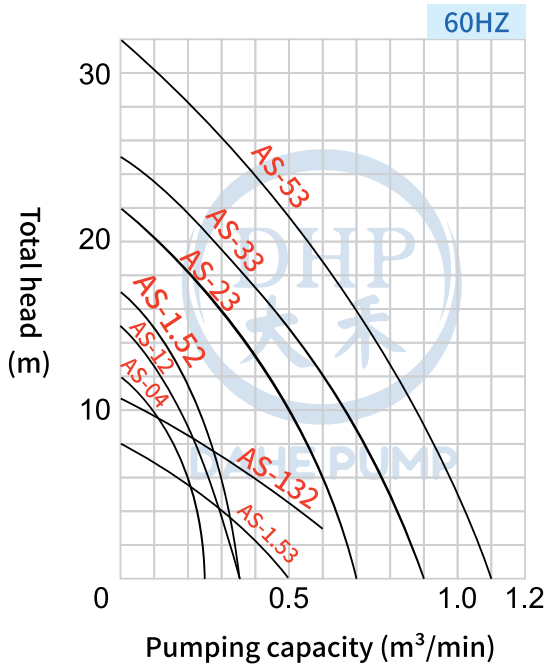

Performance Specifications Table

2P-3600RPM

Model	馬力 HP(KW)	Diamete Inch	Phase Ø	Performance		Length mm	Width mm	Height mm	Weight KG
				Head m	Water Flow m ³ /min				
AS(Q)-04(A)	1/2(0.4)	2"	(1Ø/3Ø)	8	0.16	210	160	360	13
AS(Q)-12(A)	1(0.75)	2"	(1Ø/3Ø)	9	0.2	210	160	420	16
AS-1.52	1½(1.1)	2"	(1Ø/3Ø)	12	0.2	280	180	480	24
AS-132(A)	1(0.75)	3"	(1Ø/3Ø)	6	0.4	280	160	420	19
AS-1.53(A)	1½(1.1)/4P	3"	(1Ø220V)/3Ø	5	0.25	300	200	500	28
AS(Q)-23	2(1.5)	3"	(1Ø220V)/3Ø	10	0.5	370	200	500	32
AS(Q)-33	3(2.2)	3"/4"	(1Ø220V)/3Ø	12	0.6	375	205	550	38
AS(Q)-53	5(3.7)	3"/4"	3Ø	18	0.6	360	230	560	43
AS-753	7½(5.5)	3"/4"	3Ø	20	0.8	470	300	600	75
AS(Q)-104	10(7.5)	4"	3Ø	20	1.4	610	380	735	94
AS(Q)-154	15(11)	4"	3Ø	30	1.4	610	380	710	123

- (Q)Made entirely of stainless steel
- (A)Float switch type

B Series Sewage Pumps

Applications

Civil engineering, construction, engineering, sewerage, agriculture, fisheries, animal husbandry industries, landscape waterfall water supply, low lying water accumulation, and other occasions requiring pumping and drainage.



➤ **DC-100**
DC 24V



➤ **B-02**



➤ **B-04A**



➤ **B-132**

Features

1. Small size, light weight, easy to use, and versatile in application.
2. The motor body, screws, and filter screens are all **made of stainless steel**.
3. It adopts a **mechanical shaft seal design**, with a **wear-resistant liner for the shaft**; **rubber bearing cover** effectively isolates water vapor and dust, increasing bearing life.
4. Good performance, energy-saving, large drainage volume, extremely easy maintenance.
5. This series of pumps all use brand **new motor silicon steel sheets**, and the **shaft and rotor are processed at high speed with precision**, ensuring stable motor operation. *Float switch can be optionally installed for pumps of 2HP and below.

Installation Form

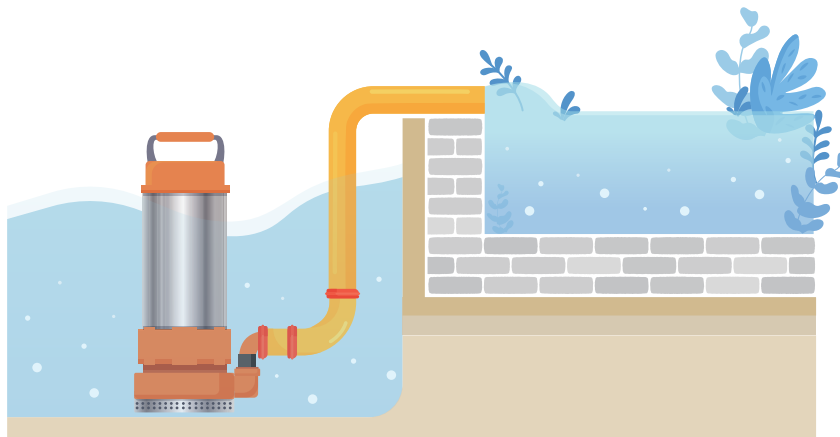

Performance Curve

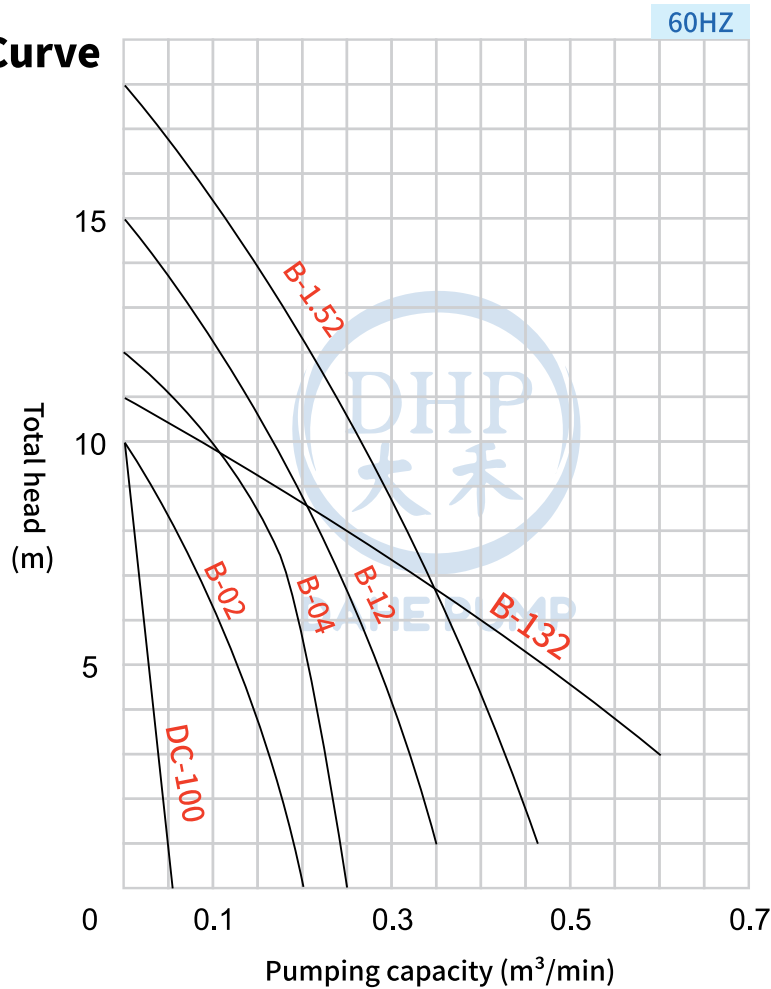

Performance Specifications Table

2P-3600RPM

Model	馬力 HP(KW)	Diamete Inch	Phase Ø	Performance		Length mm	Width mm	Height mm	Weight KG
				Head m	Water Flow m³/min				
DC-100		1"	DC 24V	6	0.02	160	110	280	2.6
B-02(A)	1/3(0.3)	1.5"	1Ø	5	0.12	195	145	295	7.5
B(Q)-04(A)	1/2(0.5)	2"	1Ø/3Ø	8	0.16	220	150	335	13
B(Q)-12(A)	1(0.75)	2"	1Ø/3Ø	10	0.17	225	150	380	17
B-132(A)	1(0.75)	3"	1Ø/3Ø	6	0.4	280	160	430	20
B-1.52	1.5(1.1)	2"	1Ø/3Ø	12	0.2	250	180	450	22

- (Q)Made entirely of stainless steel
- (A)Float switch type

B Series Sewage Pumps

Applications

Civil engineering, construction, engineering, sewerage, agriculture, fisheries, animal husbandry industries, landscape waterfall water supply, low lying water accumulation, and other occasions requiring pumping and drainage.



➤ B-22A



➤ B-24



➤ B-32

Performance Curve

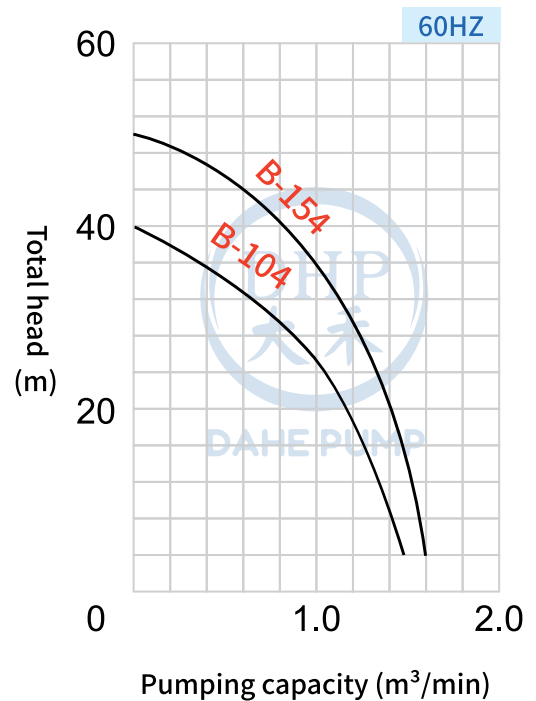
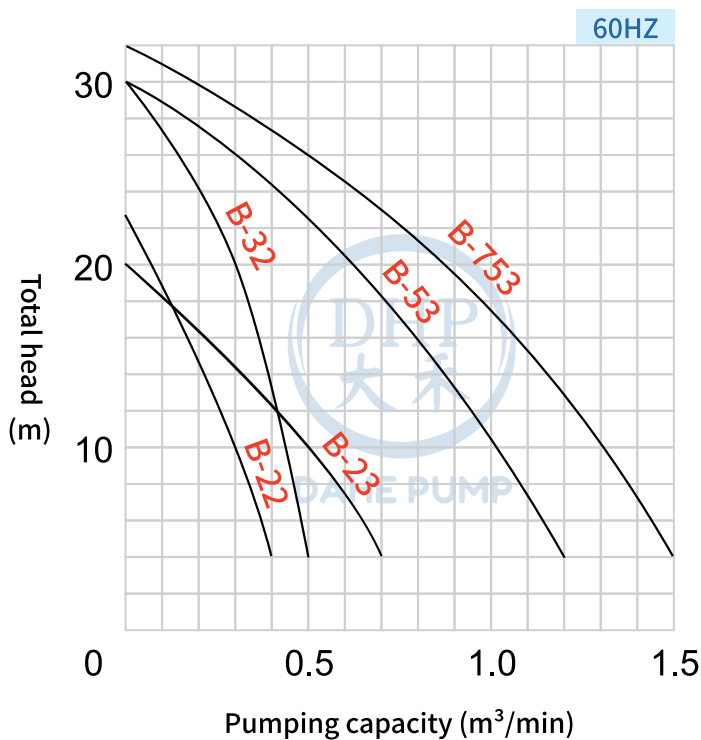

Performance Curve

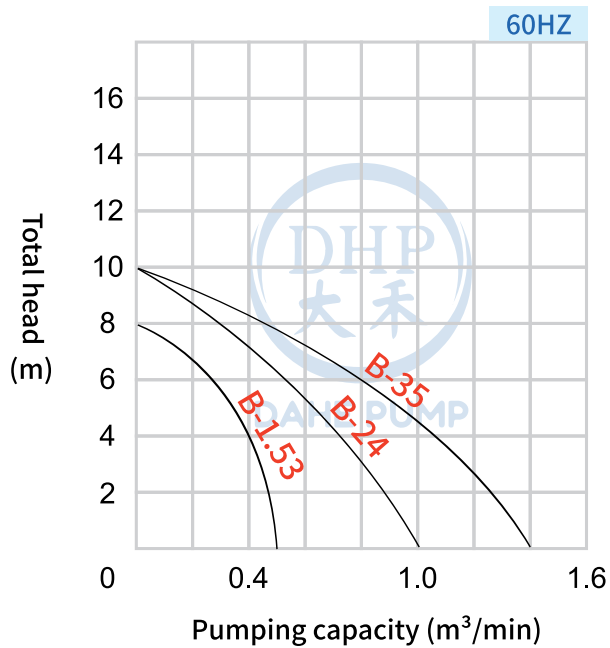

Performance Specifications Table

2P-3600RPM

Model	馬力 HP(KW)	Diamete Inch	Phase Ø	Performance		Length mm	Width mm	Height mm	Weight KG
				Head m	Water Flow m ³ /min				
B(Q)-22	2(1.5)	2"	(1Ø220V)/3Ø	15	0.2	285	205	450	29
B(Q)-23	2(1.5)	3"	(1Ø220V)/3Ø	10	0.5	310	210	450	32
B(Q)-32	3(2.2)	2"/ 3"	3Ø	20	0.3	320	220	460	35
B-53	5(3.7)	3"/ 4"	3Ø	22	0.5	360	230	560	43
B-753	7.5(5.5)	3"/ 4"	3Ø	26	0.5	470	300	600	75
B(Q)-104	10(7.5)	4"	3Ø	25	1.0	610	380	735	94
B(Q)-154	15(11)	4"	3Ø	35	1.0	610	380	710	123

■ (Q)Made entirely of stainless steel

4P-1800RPM

Model	馬力 HP(KW)	Diamete Inch	Phase Ø	Performance		Length mm	Width mm	Height mm	Weight KG
				Head m	Water Flow m ³ /min				
B-1.53	1.5(1.1)	3"	(1Ø220V)/3Ø	4	0.4	280	180	500	28
B-24	2(1.5)	4"	(1Ø220V)/3Ø	5	0.6	340	220	480	41
B-35	3(2.2)	4"/ 5"	3Ø	6	0.8	410	220	540	46

AH Type - 2P/AC Type - 4P Shallow Water Pump for Dual Use on Land and in Wells

Applications

Extraction of well water, foundation engineering, elimination of underground water seepage, agricultural irrigation, and aquaculture.



➤ AH-12

➤ AH-33

➤ AH-54

➤ AC-33

Features

1. **Dual-use for pumping and filtering water.** The filter screen can be removed and replaced with a water pipe for use as a land pump.
2. **Water-cooled cooling system** allows the motor to operate for long periods without overheating; the impeller uses a special design for high water flow.
3. The motor frame and outer cylinder are **made of stainless steel**.
 - ※ This series of pumps offers two optional accessories: a **cast iron filter screen** can be installed for submersible water discharge; changing to a **flange adapter (industrial joint)** allows the pump to be installed on land as a land pump (well pump).
 - ※ Depending on the site environment, a **replacement SIC wear-resistant shaft seal** can be selected to increase wear resistance.
 - ※ The AH model (H) pump is equipped with a **high lift impeller**.
 - ※ The AC model pump can be optionally equipped with a **copper base plate** for wear and corrosion resistance.



- Optional installation of a copper base.

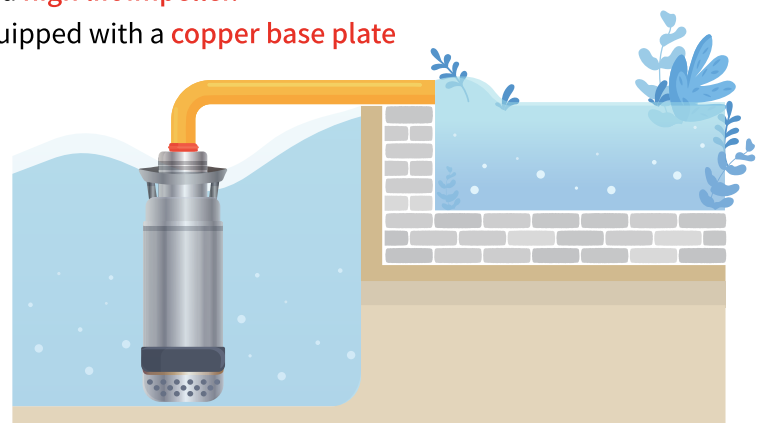

Performance Curve 60HZ

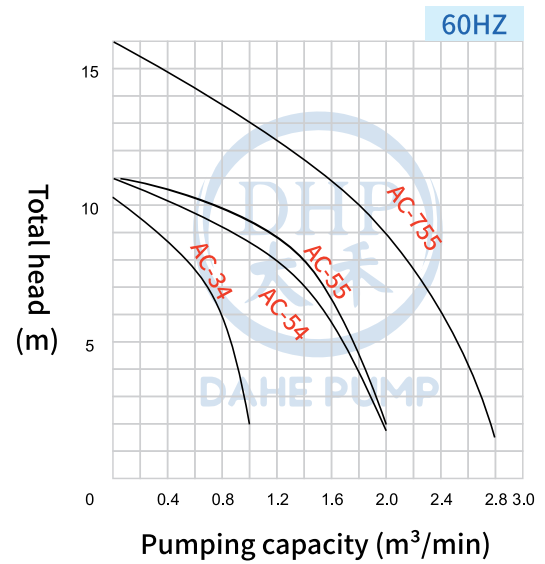
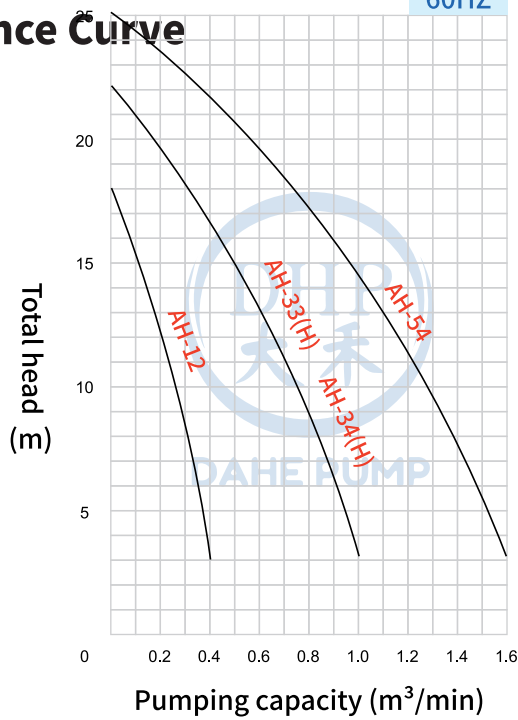

Installation Form



Performance Specifications Table

2P-3600RPM / 4P-1800RPM

Model	馬力 HP(KW)	Diameter Inch	Phase Ø	Performance		Maximum Diameter mm	Height mm	Weight KG
				Head m	Water Flow m³			
AH-12	1½(1.1)	2"	(1Ø220V/3Ø)	12	0.2	180	490	27
AH-33	3(2.2)	3"	(1Ø220V/3Ø)	12	0.65	210	580	41
AH-33H	3(2.2)	3"	(1Ø220V/3Ø)	15	0.5	210	580	41
AH-34	3(2.2)	4"	(1Ø220V/3Ø)	12	0.65	210	580	41
AH-34H	3(2.2)	4"	(1Ø220V/3Ø)	15	0.5	210	580	41
AH-54	5(3.7)	3"/4"	3Ø	15	0.95	210	600	43
AC-34	3(2.2)	3"/4"	(1Ø220V/3Ø)	6	0.8	215	540	41
AC-54	5(3.7)	4"	(1Ø220V/3Ø)	8	1.2	260	630	65
AC-55	5(3.7)	5"	(1Ø220V/3Ø)	8	1.4	260	630	65
AC-755	7½(5.5)	5"	3Ø	10	1.8	270	650	67

H-Type Large Drainage Axial Flow Pump

Applications

Specifically designed for large volume drainage of streams, rivers, agricultural irrigation, fish ponds, sewage equipment, and other industrial drainage applications.



➤ H-14



➤ H-36



➤ H-1512

Features

1. Axial flow design for stable operation, energy efficiency, and high water flow.
2. Easy operation without the need for high-pressure electrical equipment, ensuring economic efficiency, with minimal vibration and noise.
3. The pump body and motor housing are made of **sturdy and corrosion-resistant brass and stainless steel**.

Performance Curve

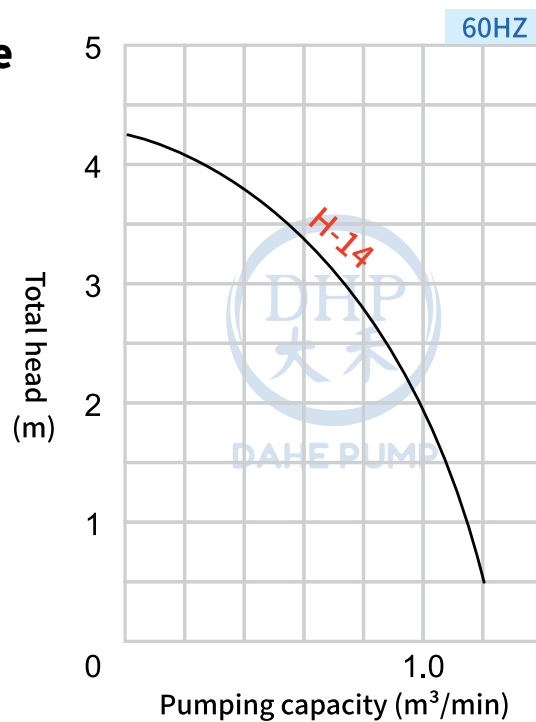

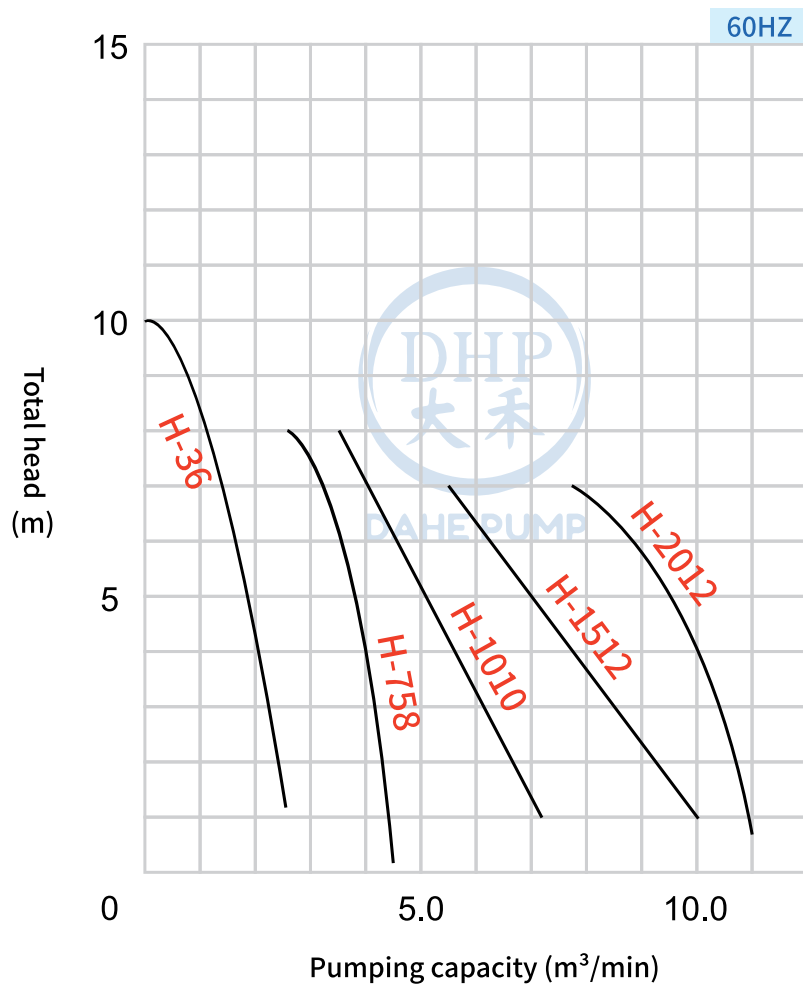

Performance Specifications Table

2P-3600RPM / 4P-1800RPM

Model	馬力 HP(KW)	Diameter Inch	Phase Ø	Number of poles	Performance		Maximum Diameter mm	Height mm	Weight KG
					Head m	Water Flow m³/min			
H-14	1(0.75)	4"	(1Ø220V/3Ø)	2	3	0.72	280	460	27
H-36	3(2.2)	6"	3Ø	4	3.6	2.4	290	580	48
H-758	7½(5.5)	8"	3Ø	4	4	4	340	970	120
H-1010	10(7.5)	10"	3Ø	4	4	5.5	400	1100	180
H-1512	15(11)	12"	3Ø	4	4	7.5	420	1100	185
H-2012	20(15)	12"	3Ø	4	4	10	420	1100	210

H Type (H) High Head, Large Volume Axial Flow Pump

Applications

Designed for large-volume water discharge in streams, rivers, agricultural irrigation, fish farming ponds, sewage systems, and other industrial drainage applications.



- Multi-stage flow guide
- ※The axial flow and diagonal flow waterway designs differ.

➤ H-108H

Features

1. Main components are made of **stainless steel**, with a **water cooled design** for efficient heat dissipation.
2. Mixed flow design for stable operation, energy efficiency, and high water flow.
3. Guide vanes and pressure relief plates are **made of wear resistant cast iron**.
4. ※This model can also be **designed as a dual use pump**.



■ Mixed Flow Impeller



■ Axial Flow Impeller

Installation Form



Performance Curve

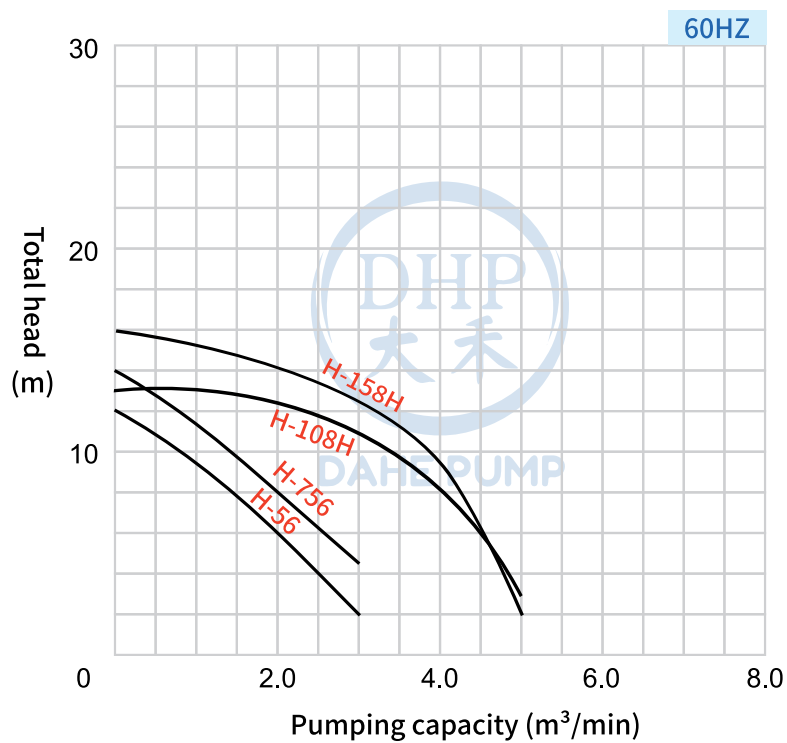

Performance Specifications Table

4P-1800RPM

Model	馬力 HP(KW)	Diameter Inch	Phase Ø	Performance		Maximum Diameter mm	Height mm	Weight KG
				Head m	Water Flow m³/min			
H-56	5(3.7)	6"	3Ø	6	2.0	260	770	78
H-756	7½(5.5)	6"	3Ø	8	2.0	265	780	80
H-108H	10(7.5)	6"/ 8"	3Ø	8.5	3.6	330	830	140
H-158H	15(11)	8"	3Ø	8.5	4	330	850	150

Vortex Type Sewage Submersible Pump for Non Clog Application

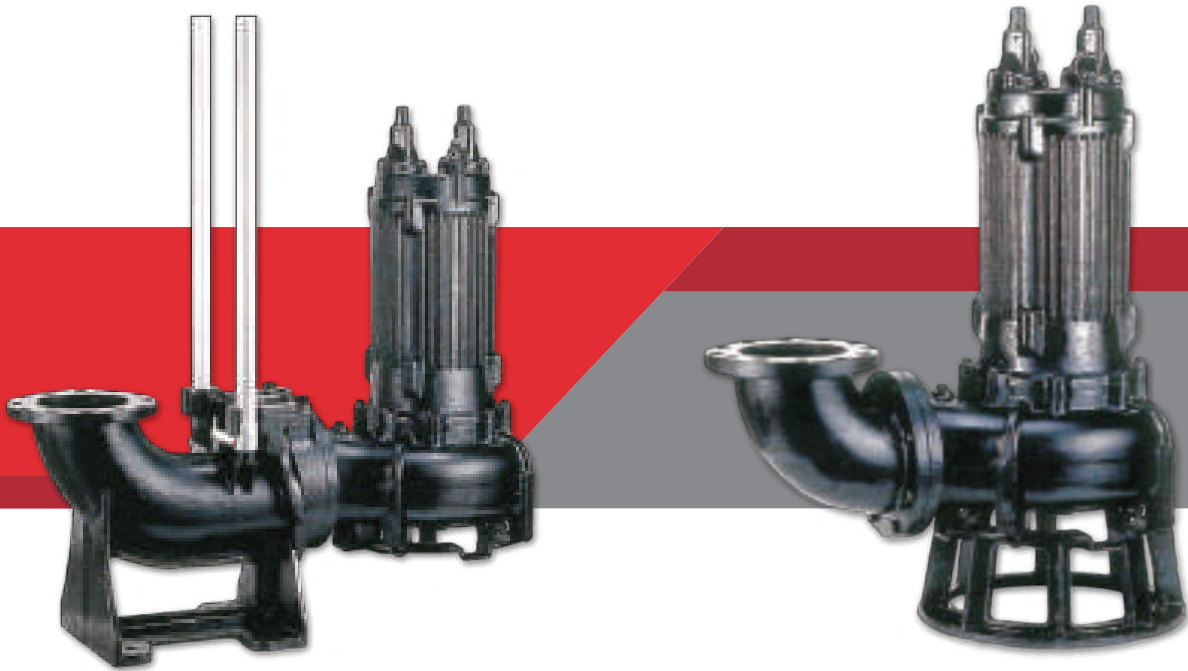

Structure and Function

1. Motor

The motor part of a submersible pump is typically a dry motor. Depending on the application, both Class E and Class F insulation materials are used.

2. Motor Protection Device

When abnormalities occur in the pump or motor, or when there are abnormal temperature rises in the motor coils, this protection device will come into effect to protect the motor.

3. Waterproof Structure of the Cable

Since the cable is often long, it is conceivable that there may be external damage or water immersion at the front end. Therefore, both the exterior and internal core wires of the cable adopt an integrated and completely waterproof structure.

4. Attachment and Detachment Device

When connecting pipes to the pump, the attachment and detachment device automatically connects and disconnects using the weight of the pump itself. This means that maintenance and inspection operations, such as checking, do not require entering the tank and can be easily completed.

5. Impeller

Depending on the pump's intended use, the impeller can be classified into various types such as open, closed, non-clog, vortex, mixed-flow, and axial-flow impellers.

6. Mechanical Shaft Seal

For the shaft seal part that prevents the motor from being submerged, a mechanical shaft seal made of Silicon Carbide is used. This material is more wear-resistant and corrosion-resistant than cemented carbide, extending the life of the pump.

FS Type Pump Structure Diagram

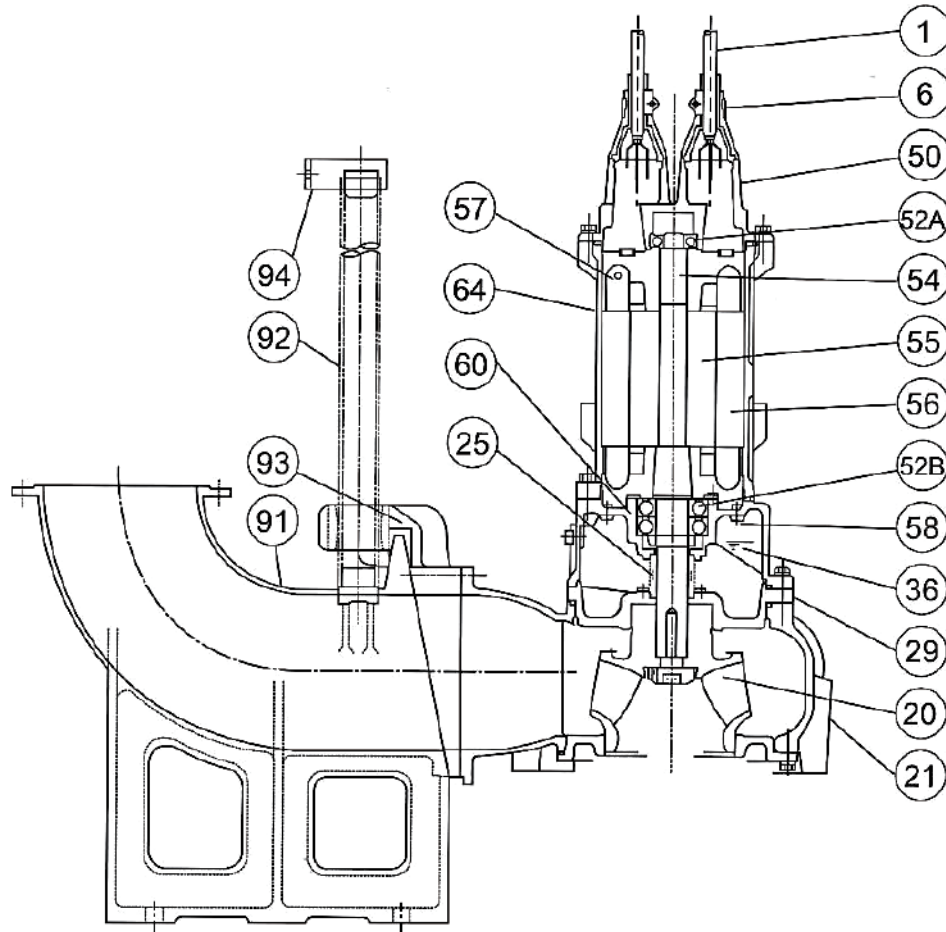

Structural Description

Item No.	Product Name	Material	Item No.	Product Name	Material
1	Cable	2PNCT	55	Rotor	
6	Cable Connector	FC200/SUS304.316	56	Stator (Coil)	
20	Pump Body	FC250/SUS304.316	57	Motor Protection Device	
21	Impeller	FC200/SUS304.316	58	Submersion Detector	
25	Mechanical Shaft Seal	Sic	60	Bearing Housing	FC200
29	Oil Chamber	FC250	64	Motor Casing	FC200/SUS304.316
36	Lubricating Oil	Turbine Oil(ISO VG32)	91	Coupling Base	FC200
50	Motor Upper Cover	FC200	92	Guide Rod	SUS304TP(非附屬)
52A	Upper Bearing		93	Coupling Hook	FCD450
52B	Lower Bearing		94	Guide Rod Support Bracket	FCD450
54	Main Shaft	SUS304/SUS316.403			

Engagement-Disengagement Type TOS Structural Diagram

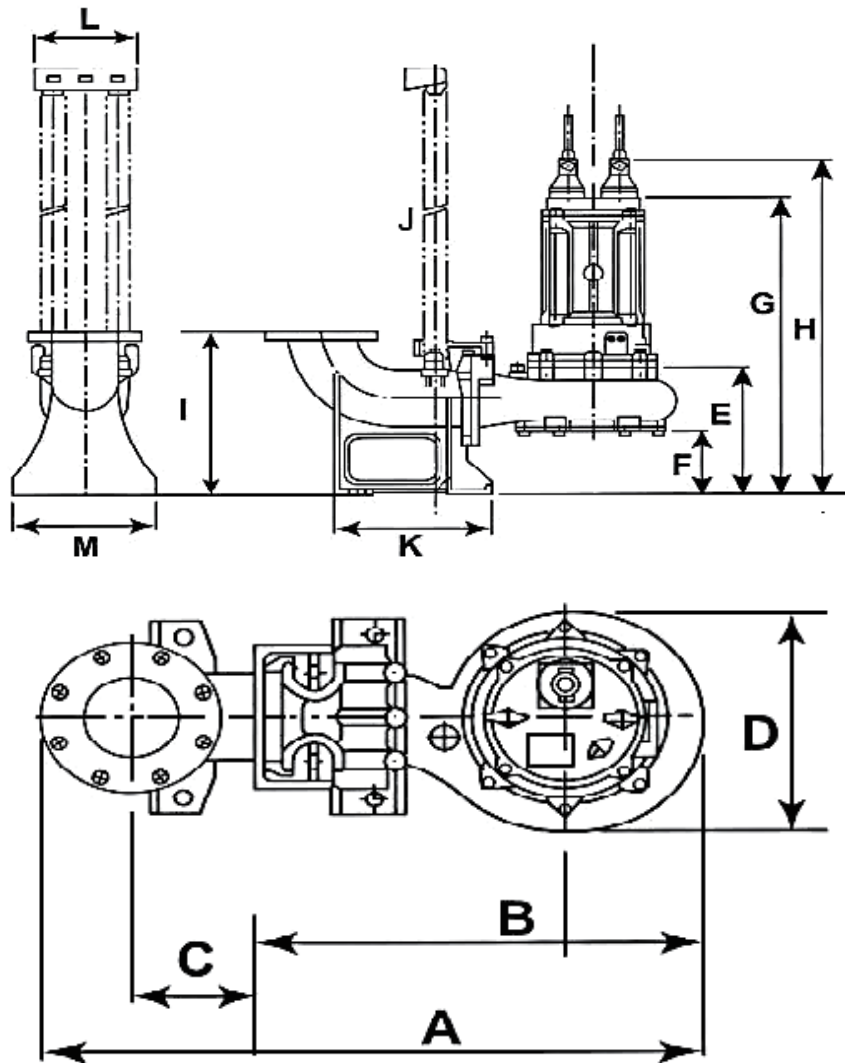

Performance Curve

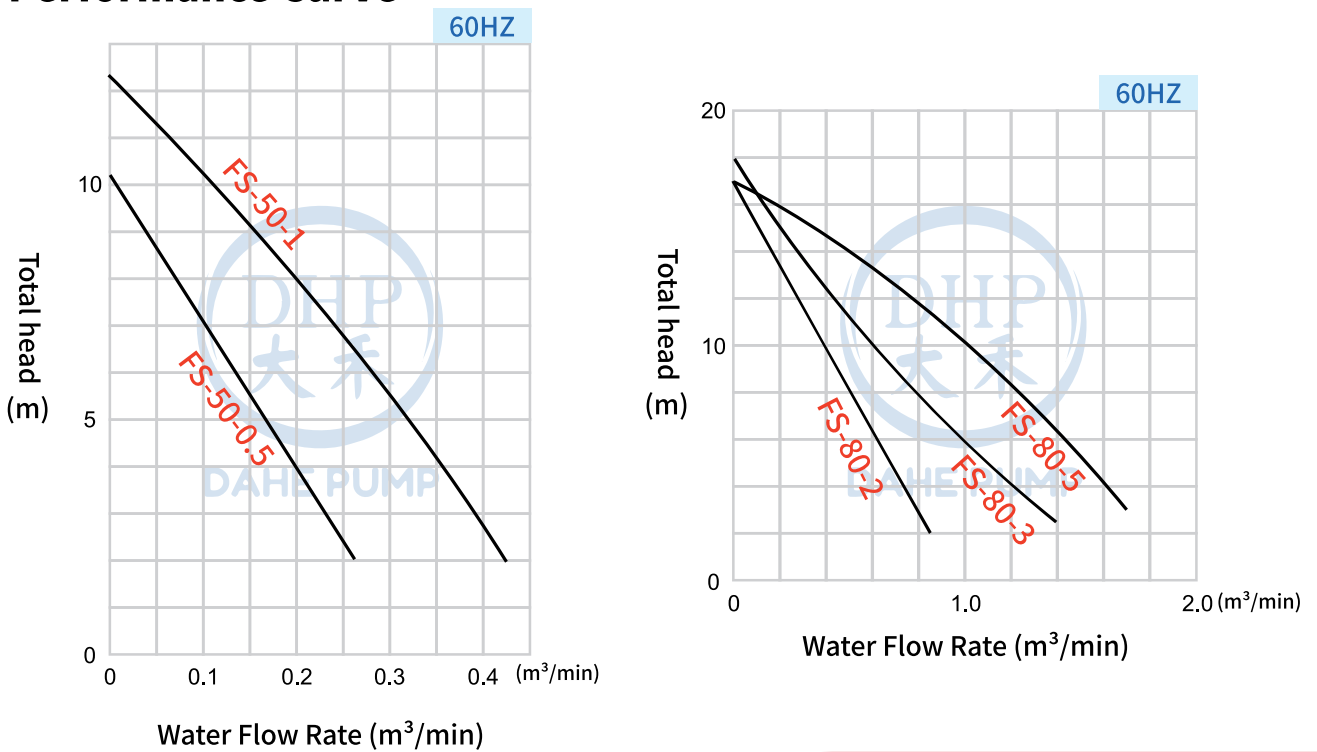

Specifications Table

Diameter	型式 Type		Output		Number of Phases PH	Voltage V	Standard Head m	Standard Water Flow Rate m ³ /min	Starting Method	Weight kg	
	Non-Attachment and Detachment Type	Attachment and Detachment Type TOS	KW	HP						With Attachment and Detachment	Without Attachment and Detachment
50 (65)	FS-50-0.5	FS-50-0.5	0.4	1/2	Single-phase/ Three-phase	110~460	7	0.1	直入	21	15
	FS-50-1	FS-50-1	0.75	1	Single-phase/ Three-phase	110~460	8	0.2	直入	32	26
80(65)	FS-80-2	FS-80-2	1.5	2	Three-phase	220/380/460	8	0.5	直入	61	40
80 (100)	FS-80-3	FS-80-3	2.2	3	Three-phase	220/380/460	10	0.6	直入	66	45
	FS-80-5	FS-80-5	3.7	5	Three-phase	220/380/460	10	1.0	直入	82	50

Attachment and Detachment Type Specification Table

Diameter	型式 Type Attachment and Detachment Type	Output		A	B	C	D	E	F	G	H	I	J	K	L	M
		KW	HP													
50 (65)	FS-50-1	0.75	1	621	368	175	250	210	40	440	476	250	25	200	230	160
	FS-50-2	1.5	2	668	410	165	250	240	50	500	533	290	32	250	230	220
80 (100)	FS-50-3	2.2	3	742	484	165	331	240	15	585	631	290	32	250	230	220
	FS-50-5	3.7	5	748	490	165	339	245	10	655	700	290	32	250	230	220

Non-Attachment and Detachment Type Specification Table

Diameter	型式 Type Non-Attachment and Detachment Type	Output		A	B	C	D	E	F	G
		KW	HP							
50 (65)	FS-50-0.5	0.4	1/2	400	348	293	360	350	140	181
	FS-50-1	0.75	1	400	350	245	410	370	140	190
80(65)	FS-80-2	1.5	2	440	390	245	480	445	185	230
80 (100)	FS-80-3	2.2	3	560	470	325	610	565	220	327
	FS-80-5	3.7	5	570	480	330	685	640	230	330

■ 非著脫式結構圖

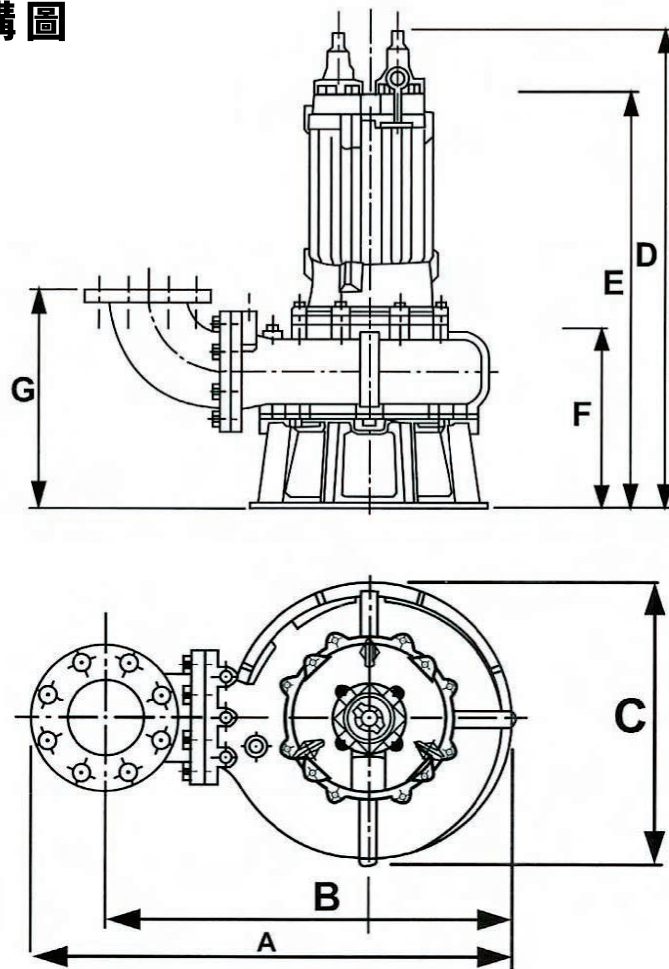

■ Performance Curve

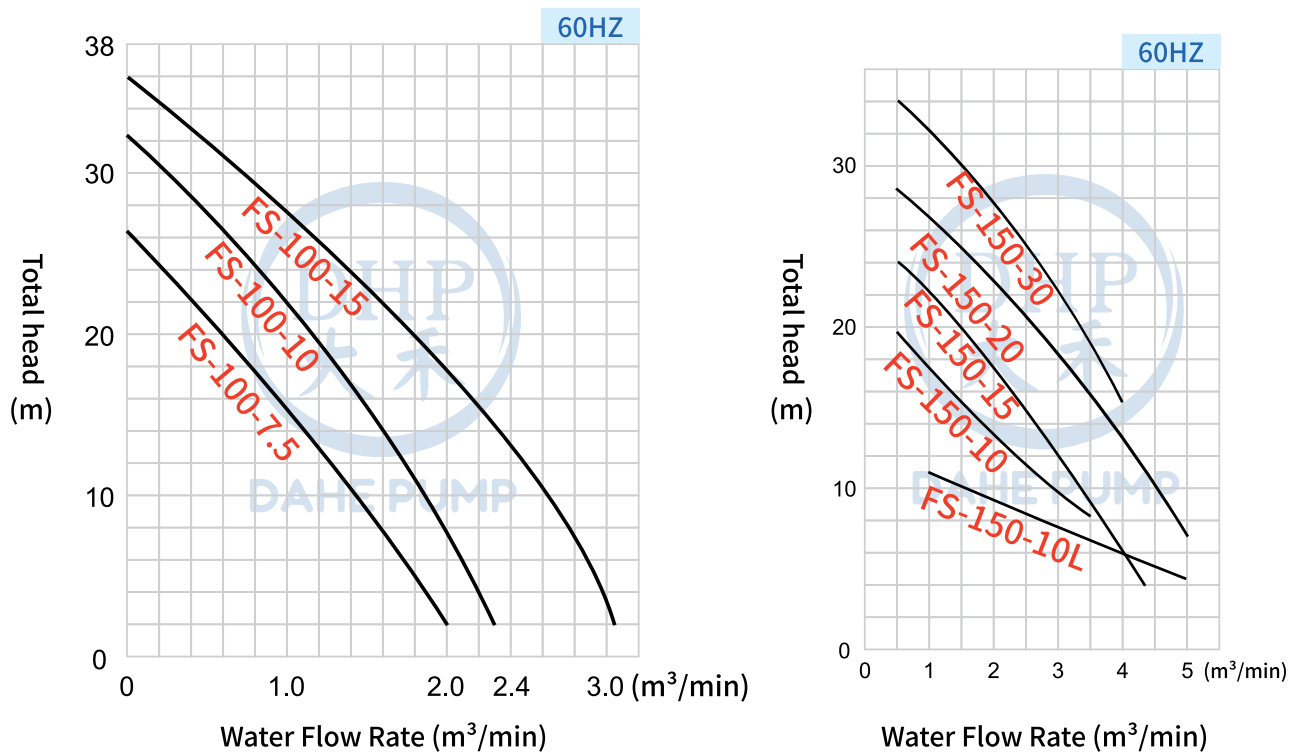

Specifications Table

Diameter	型式 Type		Output		Number of Phases PH	Voltage V	Standard Head m	Standard Water Flow Rate m ³ /min	Starting Method	Weight kg	
	Non-Attachment and Detachment Type	Attachment and Detachment Type TOS	KW	HP						With Attachment and Detachment	Without Attachment and Detachment
100 (80)	FS-100-7.5	FS-100-7.5	5.5	7.5	Three-phase	220/380/460	20.0	0.6	Direct On-Line, DOL	135	128
	FS-100-10	FS-100-10	7.5	10	Three-phase	220/380/460	20~22	1.0	Direct On-Line, DOL	152	145
	FS-100-15	FS-100-15	11	15	Three-phase	220/380/460	22	1.6	Direct On-Line, DOL	152	145
150	FS-150-10	FS-150-10	7.5	10	Three-phase	220/380/460	10.0	2.7	Direct On-Line, DOL	164	139
	FS-150-10L	FS-150-10L	7.5	10	Three-phase	220/380/460	7.2/6.0	4.0	Direct On-Line, DOL	186	161
	FS-150-15	FS-150-15	11	15	Three-phase	220/380/460	15.0	2.5	Y-△	215	189
	FS-150-20	FS-150-20	15	20	Three-phase	220/380/460	21.0	2.5	Y-△	295	270
	FS-150-30	FS-150-30	22	30	Three-phase	220/380/460	25.0	2.5	Y-△	475	425

Attachment and Detachment Type Specification Table

Diameter	型式 Type Attachment and Detachment Type	Output		A	B	C	D	E	F	G	H	I	J	K	L	M
		KW	HP													
100 (80)	FS-100-7.5	5.5	7.5	905	619	181	384	305	118	775	906	340	50	290	300	250
	FS-100-10	7.5	10	905	619	181	384	305	118	800	927	340	50	290	300	250
	FS-100-15	11	15	973	673	181	384	305	118	840	971	340	50	290	300	250
150	FS-150-10	7.5	10	1028	698	190	404	370	190	890	1016	480	50	400	330	360
	FS-150-10L	7.5	10	1065	735	190	459	400	155	900	1030	480	50	400	330	360
	FS-150-15	11	15	1096	766	190	490	370	182	890	1048	480	50	400	258	360
	FS-150-20	15	20	1097	767	190	533	370	172	970	1129	480	50	400	258	360
	FS-150-30	22	30	1164	834	190	560	370	143	400	1260	480	50	400	258	360

Non-Attachment and Detachment Type Specification Table

Diameter	型式 Type Non-Attachment and Detachment Type	Output		A	B	C	D	E	F	G
		KW	HP							
100 (80)	FS-100-7.5	5.5	7.5	660	580	400	900	770	330	370
	FS-100-10	7.5	10	660	580	400	920	795	330	370
	FS-100-15	11	15	687	582	400	1011	835	335	312
150	FS-150-10	7.5	10	830	690	415	960	835	330	405
	FS-150-10L	7.5	10	865	786	482	1080	950	445	510
	FS-150-15	11	15	896	756	502	1075	915	395	480
	FS-150-20	15	20	900	757	546	1159	999	395	480
	FS-150-30	22	30	975	836	565	1310	403	395	506

Performance Curve

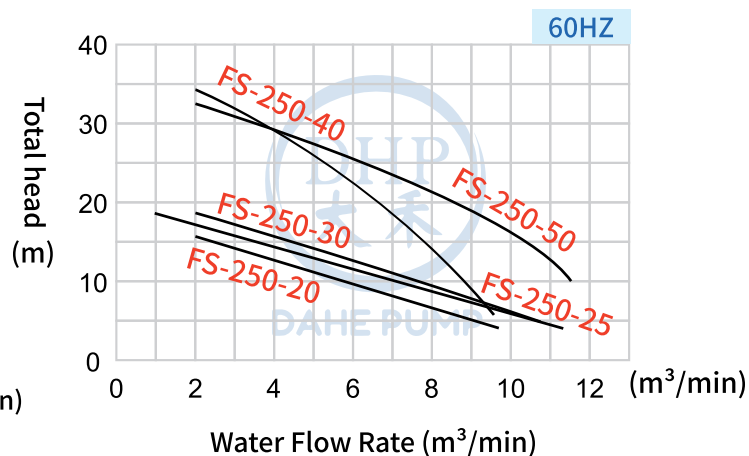
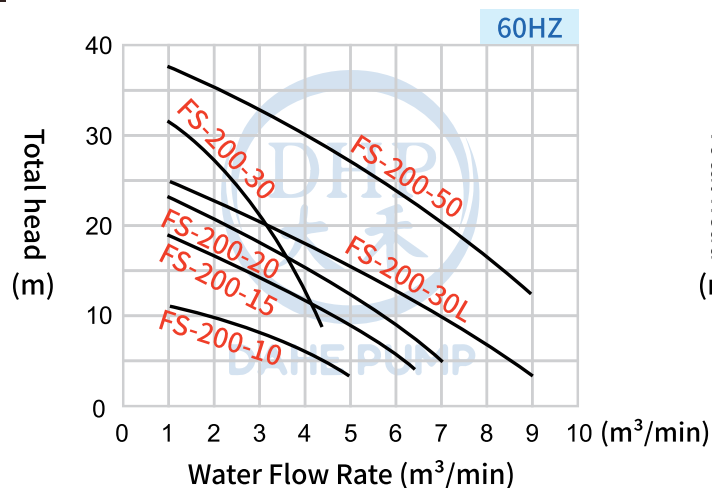

Specifications Table

Diameter	型式 Type		Output		Number of Phases PH	Voltage V	Standard Head m	Standard Water Flow Rate m ³ /min	Starting Method	Weight kg	
	Non-Attachment and Detachment Type	Attachment and Detachment Type TOS	KW	HP						With Attachment and Detachment	Without Attachment and Detachment
200	FS-200-10	FS-200-10	7.5	10	Three-phase	220/380/460	7.2/6.0	4.0	Direct On-Line, DOL	199	193
	FS-200-15	FS-200-15	11	15	Three-phase	220/380/460	10.0	4.5	Y-△	250	245
	FS-200-20	FS-200-20	15	20	Three-phase	220/380/460	14.0	4.5	Y-△	285	300
	FS-200-30	FS-200-30	22	30	Three-phase	220/380/460	25.0	2.5	Y-△	445	480
	FS-200-30L	FS-200-30L	22	30	Three-phase	220/380/460	16.0	4.5	Y-△	610	650
	FS-200-50	FS-200-50	37	50	Three-phase	220/380/460	28.0	4.5	Y-△	610	650
250	FS-250-20	FS-250-20	15	20	Three-phase	220/380/460	9.0	7.0	Y-△	380	420
	FS-250-25	FS-250-25	18.5	25	Three-phase	220/380/460	7.0	10.0	Y-△	380	445
	FS-250-30	FS-250-30	22	30	Three-phase	220/380/460	13.0/11.5	7.0	Y-△	620	680
	FS-250-40	FS-250-40	30	40	Three-phase	220/380/460	16.3/13.0	7.0	Y-△	705	745
	FS-250-50	FS-250-50	37	50	Three-phase	220/380/460	22.0	7.0	Y-△	705	745

Attachment and Detachment Type Specification Table

Diameter	型式 Type	Output		A	B	C	D	E	F	G	H	I	J	K	L	M
	Attachment and Detachment Type	KW	HP													
200	FS-200-10	7.5	10	1264	869	230	458	420	175	920	1050	550	40	450	380	400
	FS-200-15	11	15	1264	869	230	458	410	163	940	1096	550	40	450	380	400
	FS-200-20	15	20	1235	840	230	433	450	165	1005	1161	550	40	450	380	400
	FS-200-30	22	30	1365	970	230	560	450	163	400	1283	550	40	450	380	400
	FS-200-30L	22	30	1449	1054	230	705	450	100	500	1310	550	40	450	380	400
	FS-200-50	37	50	1381	986	230	610	450	170	450	1367	550	40	450	380	400
250	FS-250-20	15	20	1451	951	300	496	500	166	1035	1194	630	40	560	380	460
	FS-250-25	18.5	25	1462	951	300	496	500	170	1040	1240	630	40	560	380	460
	FS-250-30	22	30	1570	1070	300	705	500	123	500	1333	630	40	560	380	460
	FS-250-40	30	40	1533	1033	300	669	500	193	500	1390	630	40	560	380	460
	FS-250-50	37	50	1533	1033	300	669	560	193	500	1390	630	40	560	380	460

Non-Attachment and Detachment Type Specification Table

Diameter	型式 Type	Output		A	B	C	D	E	F	G
	Non-Attachment and Detachment Type	KW	HP							
200	FS-200-10	7.5	10	923	760	485	1082	953	448	543
	FS-200-15	11	15	923	760	485	1128	973	448	543
	FS-200-20	15	20	970	803	523	1193	1037	448	543
	FS-200-30	22	30	1020	803	558	1298	398	448	528
	FS-200-30L	22	30	1143	978	713	1448	598	448	648
	FS-200-50	37	50	1070	905	624	1418	498	448	558
250	FS-250-20	15	20	1144	945	556	1226	1068	498	615
	FS-250-30	22	30	1250	1049	710	1445	595	498	698
	FS-250-40	30	40	1210	1010	665	1417	495	498	607
	FS-250-50	37	50	1210	1010	665	1417	495	498	607

Performance Curve

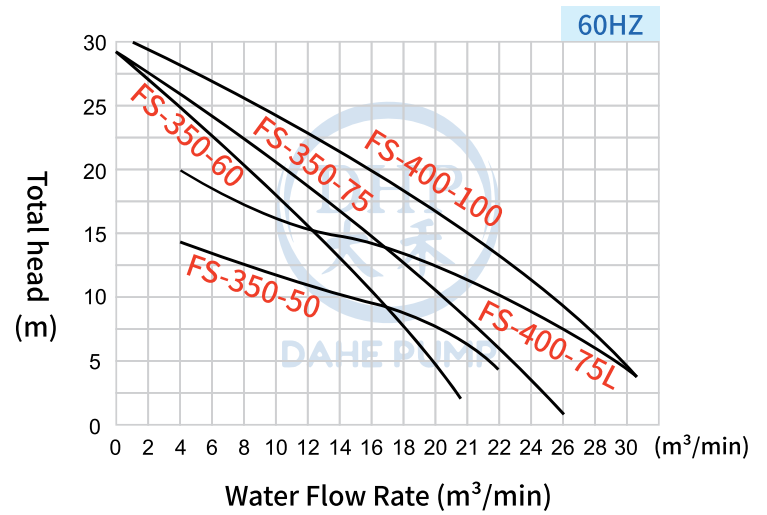
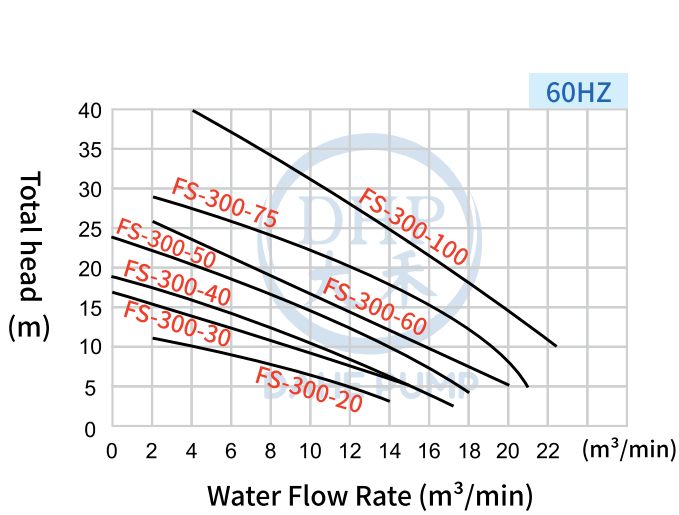

Specifications Table

Diameter	型式 Type		Output		Number of Phases PH	Voltage V	Standard Head m	Standard Water Flow Rate m ³ /min	Starting Method	Weight kg	
	Non-Attachment and Detachment Type	Attachment and Detachment Type TOS	KW	HP						With Attachment and Detachment	Without Attachment and Detachment
300	FS-300-20	FS-300-20	15	20	Three-phase	220/380/460	6.5	10.0	Direct On-Line, DOL	550	510
	FS-300-30	FS-300-30	22	30	Three-phase	220/380/460	9.0	10.0	Y-△	730	660
	FS-300-40	FS-300-40	30	40	Three-phase	220/380/460	10.0	10.5	Y-△	810	740
	FS-300-50	FS-300-50	37	50	Three-phase	220/380/460	15.0	10.0	Y-△	810	740
	FS-300-60	FS-300-60	45	60	Three-phase	220/380/460	17.0/18.0	10.0	Y-△	1300	1230
	FS-300-75	FS-300-75	55	75	Three-phase	220/380/460	20.0/21.0	10.0	Y-△	1550	1500
	FS-300-100	FS-300-100	75	100	Three-phase	220/380/460	31.0	10.0	Y-△	1150	1100
350	FS-350-50	FS-350-50	37	50	Three-phase	220/380/460	9.0	15.0	Y-△	1000	900
	FS-350-60	FS-350-60	45	60	Three-phase	220/380/460	12.0	15.0	Y-△	1450	1350
	FS-350-75	FS-350-75	55	75	Three-phase	220/380/460	16.0	15.0	Y-△	1750	1700
400	FS-400-75L	FS-400-75L	55	75	Three-phase	220/380/460	12.0	21.0	Y-△	1750	1700
	FS-400-100	FS-400-100	75	100	Three-phase	220/380/460	17.0	20.0	Y-△	1845	1795

Attachment and Detachment Type Specification Table

Diameter	型式 Type	Output		A	B	C	D	E	F	G	H	I	J	K	L	M
	Attachment and Detachment Type	KW	HP													
300	FS-300-20	15	20	1668	1143	300	653	560	180	135	1274	810	65	630	700	600
	FS-300-30	22	30	1700	1177	300	720	560	180	600	1384	810	65	630	700	600
	FS-300-40	30	40	1725	1202	300	755	560	180	600	1475	810	65	630	700	600
	FS-300-50	37	50	1725	1202	300	755	560	180	600	1475	810	65	630	700	600
	FS-300-60	45	60	1780	1257	300	830	560	173	700	1721	810	65	630	700	600
	FS-300-75	55	75	1780	1257	300	830	560	173	700	1766	810	65	630	700	600
	FS-300-100	75	100	1795	1272	300	830	560	205	700	1666	810	65	630	700	600
350	FS-350-50	37	50	1715	1140	330	720	560	200	650	1548	880	65	650	700	640
	FS-350-60	45	60	1859	1284	330	830	560	200	800	1748	880	65	650	700	640
	FS-350-75	55	75	2137	1387	470	790	1020	320	1970	2460	1060	100	1110	930	750
400	FS-400-75L	55	75	2137	1387	470	790	1020	320	1970	2460	1060	100	1110	930	750
	FS-400-100	75	100	2137	1383	470	790	1020	320	1970	2460	1060	100	1110	930	750

Non-Attachment and Detachment Type Specification Table

Diameter	型式 Type	Output		A	B	C	D	E	F	G
	Non-Attachment and Detachment Type	KW	HP							
300	FS-300-20	15	20	1302	1079	656	1314	1175	600	745
	FS-300-30	22	30	1340	1117	710	1440	597	598	763
	FS-300-40	30	40	1358	1135	753	1533	597	598	763
	FS-300-50	37	50	1358	1135	753	1533	597	598	763
	FS-300-60	45	60	1410	1187	827	1785	679	598	770
	FS-300-75	55	75	1410	1187	827	1830	679	598	770
	FS-300-100	75	100	1433	1210	750	1700	700	600	740
350	FS-350-50	37	50	1355	1110	728	1585	679	645	835
	FS-350-60	45	60	1625	1345	797	1836	679	945	977
	FS-350-75	55	75	1625	1345	797	1880	679	945	977
400	FS-400-75L	55	75	1625	1345	797	1877	679	945	977
	FS-400-100	75	100	1615	1335	797	1878	679	945	970

Other Products

Stainless Steel Sewage Pump

Applications

Chemical plants, metal plants, pollution plants, comprehensive wastewater treatment; special liquid transport circulation.



➤ **ASQ-04**
(1/2HP) Float Switch



➤ **SQ-23(2HP)**



➤ **ASQ-54(5HP)**



➤ **BQ-04(1/2HP)**



➤ **BQ-22(2HP)**



➤ **BQ-104(10HP)**

Vertical Multi-Stage Pump (Two-Stage Double Impeller)

Applications

Eel Pump / Eel Suction Machine Quickly sucks eels into the eel selection pool, significantly improving the efficiency of eel fishing. Features

It has the ability to lift water to a great height and deliver it over long distances (up to 600 meters).



➤ H-106T(10HP)

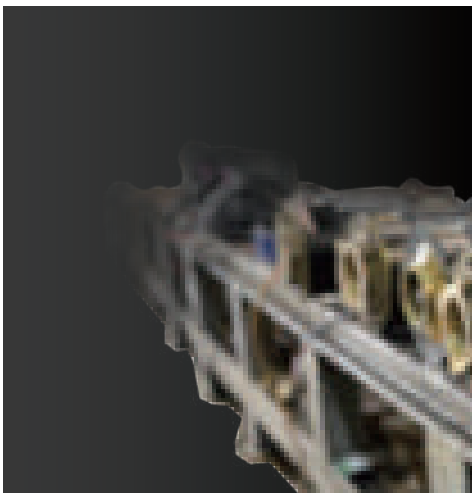

**For various specifications and detailed information,
feel free to contact us.**

Service Process



1. Preliminary Consultation

Understand the customer, identify their needs, and effectively resolve their initial professional issues.

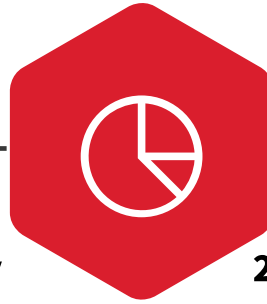

2. Analysis and Recommendations

Confirm the customer's implementation direction and accurately analyze the functionality of different products to determine whether they meet the requirements.

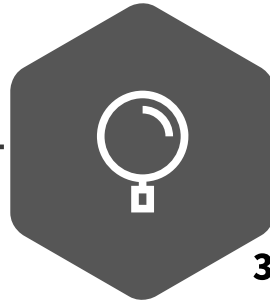

3. Research and Development (R&D) and Manufacturing

For different cases, we offer partial product customization to ensure that customers receive products that meet their expectations.



4. Maintenance and Warranty

For non-human-induced damages, we provide repair and warranty services, ensuring your peace of mind and protection.



5. Secure Delivery

Dahe's professional quality and trustworthy service give you a warm and welcoming experience. With Dahe's dedication, you can rest assured.

/// ABOUT US ///

Dahe Pumps FENG HE ELECTRIC CO., LTD.

Dahe Pumps FENG HE ELECTRIC CO., LTD. is a manufacturer of submersible pumps with 40 years of professional technical manufacturing and sales experience. With the development and transformation of Taiwan's manufacturing industry, innovative technology and honest service, improving customer satisfaction is our goal. We hope to provide our partners with excellent product quality and service through our team's pursuit of perfection.



Strict Quality Control

The product quality undergoes strict quality control and periodic inspections are carried out to verify the production process. The company is a professional and reliable submersible pump manufacturer.



Integrity in Service

We ensure that the performance and quality of all products meet the requirements of various industries, aiming to earn customer trust and provide comprehensive and prompt services.



Innovative Technology

The company continuously engages in the development of product technology, overcoming challenges in manufacturing techniques, and creating highly adaptable and reliable products for environmental applications.



DAHE PUMP

Dahe is your reliable partner in water solutions.